

DEVILBISS

SB-E1-2-532 ISS.08

Compact
by DEVILBISS

CE ϵ x II 2 G X

Operation Manual

HVLP & Trans-Tech[®] Suction Feed Spraygun



E

P 1 - 12



DEVILBISS



Operation Manual COMPACT – Suction Feed Spraygun Important



Read and follow all instructions and Safety Precautions before using this equipment

Description

The Compact Suction feed Spraygun Kit complies to ATEX regulations **94/9/EC**, protection level;
II 2 G X, Suitable for use in Zones 1 and 2

Important: : These Sprayguns are suitable for use with both waterbased and solvent based coating materials. The design uses EPA compliant (Devilbiss Trans-Tech®) and HVLP atomising technology to reduce overspray and improve coating efficiency. These guns are not designed for use with highly corrosive and/or abrasive materials and if used with such materials it must be expected that the need for cleaning and/or replacement of parts will be increased. If there is any doubt regarding the suitability of a specific material contact your local Distributor or ITW Finishing direct.

	Model Part Number
Example:	COM-S510B-16
Aircap _____	↑ ↑ ↑
Gunbody Finish _____	↑
B= Blue Anodised	
	Fluid nozzle size (16 = 1,6 mm)

EC Declaration of Conformity
We: ITW Finishing UK, Ringwood Rd, Bournemouth, Dorset, BH11 9LH, UK , as the manufacturer of the Spraygun model Compact , declare, under our sole responsibility, that the equipment to which this document relates is in conformity with the following standards or other normative documents:
BS EN 292-1 PARTS 1 & 2: 1991, BS EN 1953: 1999; and thereby conform to the protection requirements of Council Directive 98/37/EC relating to Machinery Safety Directive , and;
EN 13463-1:2001 , council Directive 94/9/EC relating to Equipment and Protective Systems intended for use in Potentially Explosive Atmospheres protection level II 2 G X .
This product complies with the requirements of the EPA guidelines, PG6/34,PG6/20 and PG6/23. Achieving transfer efficiency in excess of 65%.
B. Holt , General Manager 30th June 2003

ITW Finishing Systems and Products reserve the right to modify equipment specification without prior notice.



SAFETY WARNINGS



Fire and explosion

Solvents and coating materials can be highly flammable or combustible when sprayed. **ALWAYS refer to the coating material suppliers instructions and COSHH sheets before using this equipment**



Users must comply with all local and national codes of practice and insurance company requirements governing ventilation, fire precautions, operation and house-keeping of working areas



This equipment, as supplied, is NOT suitable for use with Halogenated Hydrocarbons.



Static Electricity can be generated by fluid and/or air passing through hoses, by the spraying process and by cleaning non-conductive parts with cloths. To prevent ignition sources from static discharges, earth continuity must be maintained to the spraygun and other metallic equipment used. It is essential to use conductive air and/or fluid hoses.



Personal Protective Equipment



Toxic vapours – When sprayed, certain materials may be poisonous, create irritation or be otherwise harmful to health.

*Always read all labels and safety data sheets for the material before spraying and follow any recommendations. **If In Doubt, Contact Your Material Supplier***



The use of respiratory protective equipment is recommended at all times. The type of equipment must be compatible with the material being sprayed.

Always wear eye protection when spraying or cleaning the spraygun



Gloves must be worn when spraying or cleaning the equipment



Training – Personnel should be given adequate training in the safe use of spraying equipment.

Misuse

Never aim a spraygun at any part of the body

Never exceed the max. recommended safe working pressure for the equipment

The fitting of non-recommended or non-original spares may create hazards

Before cleaning or maintenance, all pressure must be isolated and relieved from the equipment

The product should be cleaned using a gun washing machine. However, this equipment should not be left inside gun washing machines for prolonged periods of time.

Noise Levels

The A-weighted sound level of sprayguns may exceed 85 dB (A) depending on the set-up



being used. Details of actual noise levels are available on request. It is recommended that ear protection is worn at all times when spraying.

Operating

Spray Equipment using high pressures may be subject to recoil forces. Under certain circumstances, such forces could result in repetitive strain injury to the operator.

Parts List

	Ref. No	Description	Part Number	Qty	Options
	1	Air Cap/Retaining ring	See Selection Chart	1	
+	2	Nozzle	See Selection Chart	1	
+	3	Separator	SP-623-K5	5	
+	4	Packing	GTI-445-K2	2	
	5	Spreader Valve	SP-401-K	1	
	6	Stud and Screw	GTI-408-K5	5	
	7	Needle Adjusting Screw	SP-614-K	1	
+	8	Spring	SP-622-K5	1	
+	9	Needle	See Selection Chart	1	
	10	Airvalve housing + seal	SP-612-K	1	
+	11	Spindle		1	
	12	Trigger	SP-617-K	1	
	13	Connector	SP-611-K	1	
+	14	Airflow Valve	SP-402-K	1	
	15	Fluid Inlet Connector and seal	SP-610-K	1	
+	16	Air Valve Service Kit	SPK-101-K	1	
	17	Retaining Ring and Seals	SPK-102-K	1	
+	18	Spreader/ Cheater Service Kit	GTI-428-K5	5	
	19	Circlip	25746-007-K5	5	
	20	Lid Gasket - kit of 3	KR-11-K3	1	
	21	Drip free diaphragm—kit of 5	KR-115-K5	1	
	22	Cup - Blue anodised	KRW-401-K	1	
	23	Cup lid assembly	KRW-4001-B	1	
	24	Cup - Blue anodised	KRW-502-B	1	
+	25	Air valve assembly Tool		1	
	26	Spanner	SPN-5	1	
		Spraygun Service Kit (parts included marked +)	SPK-401-**	1	16,18,20,22 e.g **=16 =1.6 mm
		Spraygun Service Kit (parts included marked *)	SPK-402-**	1	16,18,20,22 e.g **=16 =1.6 mm

CHART : AIR CAPS / NOZZLES AND NEEDLE COMBINATIONS

		AIR CAP/RETAINING RING SP-100-***-K e.g *** = 430			
		CONVENTIONAL		HVLP	TRANS -TECH
		430,497,443,	470	505	510,522,523,513,
Nozzle	SP-200S-**-K e.g ** =14 =1.4mm	085,10,12,13,14, 16,18,20,22		085,10,12,13,14, 16,18,20,22	085,10,12,13, 14,16,18,20,22
Needle	SP-300S-**-K e.g ** =14 =1.4mm	085,10,12,13,14, 16,18,20,22,28		085,10,12,13, 14,16,18,20,22	085,10,12,13, 14,16,18,20,22
Needle Plastic tipped	SP-300P-**-K e.g ** =14 =1.4mm	10, 12, 14		10, 12, 14	10, 12, 14
Nozzle Hard- ened	SP-200N-**-K e.g ** =14 =1.4mm	14,18, 22		14,18, 22	14,18, 22
Nozzle Hardened (Air Cap 470 only)	SP-247N-**-K e.g ** =22 =2.2mm	22,28			
Needle Hardened	SP-300N-**-K e.g ** =14 =1.4mm	14,18,22		14, 18, 22	14, 18, 22
Nozzle (Air Cap 590 only)	SP-259S-**-K e.g **=10=1.0mm				05,07,10
Nozzle (Air Cap 470 only)	SP-247S-**-K e.g ** =22 =2.2mm	22,28			



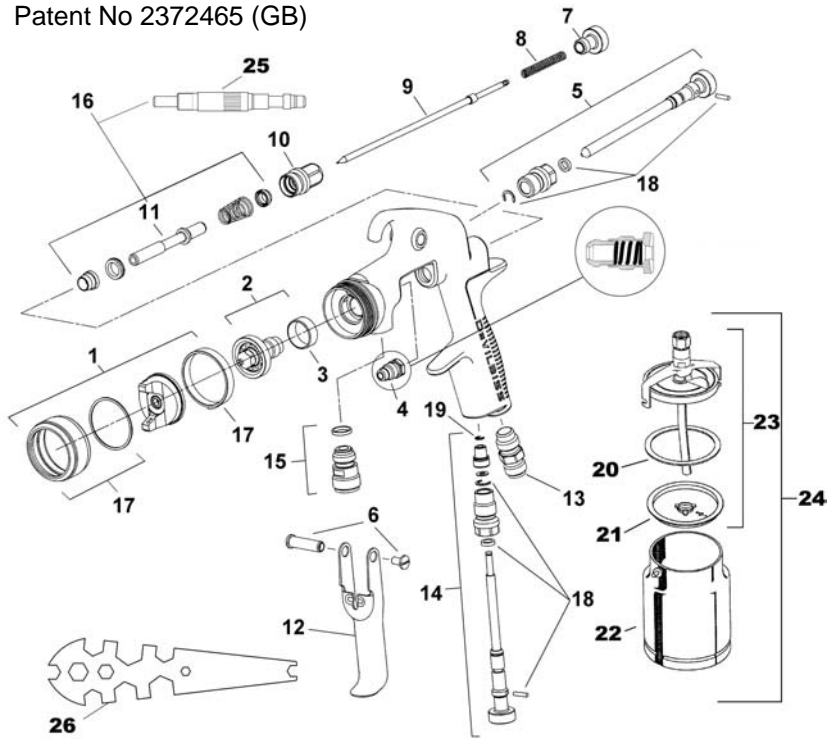

Specification

Air supply connection -	Universal 1/4" BSP and NPS
Fluid Supply Connection -	Universal 3/8" BSP and NPS
Maximum static Air inlet pressure -	P ₁ = 12 bar (175 psi)
Maximum static Fluid inlet pressure -	P ₂ = 15 bar (218 psi)
Nominal gun Air inlet pressure - with gun triggered	2. bar (29 psi) 522 & 510 Trans-Tech Air Cap 1.4 bar (20 psi) 505 HVLP Air Cap
Maximum Service temperature	40°C
Gun Weight -	934 g
Materials of Construction	
Gun body	Anodised Aluminium
Nozzle	Stainless Steel
Needle	Stainless Steel
Fluid Inlet	Stainless Steel / PTFE
Trigger	Nickel Plated Steel
Cup	Anodised Aluminium
Cup Lid	Nickel Plated Aluminium
Yoke	Nickel Plated Steel

Installation

Important: *To ensure that this equipment reaches you in first class condition, protective coatings have been used. Flush the equipment through with a suitable solvent before use.*

1. Attach air hose to connector (13). Recommended hose size 8 mm bore. The hose must be conductive and electrical bond from the spraygun to earth should be checked with an ohmeter. A resistance of less than 10^6 Ohms is recommended.
2. Attach the Cup Lid assembly (27) to the Fluid Inlet connector (15).
3. Position the Yoke at right angles to the Gun with the Cam lever (21) to the front (see picture). Make sure the vent hole in the lid is positioned under the Yoke and the hole in the diaphragm (25) is 180° to the Lid vent hole.

Operation

1. Mix coating material to manufacturers instructions.
2. Fill the cup with the required amount of material. Fill to no more than 25mm (1") from the top of the cup. DO NOT OVERFILL.
3. Attach Cup to the Lid assembly.
4. Turn needle adjusting screw (7) clockwise to prevent movement.
5. Turn spreader valve (5) counter-clockwise to fully open.
6. Adjust inlet air pressure (For recommended figures see Specifications) at the gun inlet with the gun triggered. (*pressure gauge attachment shown under Accessories is recommended for this*).
7. Turn needle adjusting screw counter clockwise until first thread shows.
8. Test spray. If the finish is too dry reduce airflow by reducing air inlet pressure or by the Airflow Valve (14). Screw the Adjusting Knob (14) in to reduce pressure.
9. If finish is too wet reduce fluid flow by turning needle screw (7) clockwise or reducing the fluid pressure. If atomisation is too coarse, increase inlet air pressure. If too fine reduce inlet pressure.
10. The pattern size can be reduced by turning adjusting valve (5) clockwise.
11. Hold gun perpendicular to surface being sprayed. Arcing or tilting may result in uneven coating.
12. The recommended spray distance is 150-200 mm (6"-8").
13. Spray edges first. Overlap each stroke a minimum of 50%. Move gun at a constant speed.
14. Always turn off air supply and relieve pressure when gun is not in use.

Preventative Maintenance

1. Turn off air and relieve pressure in the supply lines, or if using QD system, disconnect from airline.
2. Release Cup and raise the tube out of the material. Trigger the Gun and allow material to drain back into the cup. Dispose of the surplus material.
3. Clean the cup. Remove the Drip free diaphragm and clean. Replace the diaphragm if is split or damaged.
4. Check the breather hole in the Lid is not blocked.
5. Remove air cap (1) and clean. If any of the holes in the cap are blocked with coating material use a toothpick to clean. Never use metal wire which could damage the cap and produce distorted spray patterns
6. Ensure the tip of the nozzle (2) is clean and free from damage. Build up

of dried paint can distort the spray pattern.

7. Lubrication – stud/screw (6), needle (9) and air valve (11) should be oiled each day.

Replacement of Parts

Nozzle (2) and Needle (9) – Remove parts in the following order: 7, 8, 9, 1 and 2. Replace any worn or damaged parts and re-assemble in reverse order. Recommended tightening torque for nozzle (2) 9.5-12 Nm (80-100 lbf in).

Packing – Remove parts 7, 8, 9. Unscrew cartridge (4). Fit new cartridge finger tight. Re-assemble parts 9, 8, and 7 and tighten cartridge (4) with spanner sufficient to seal but to allow free movement of needle. Lubricate with gun oil.

Air Valve Seal Kit (16) - (Refer to photos 1 to 28 and fig 2)

1. Remove Adjusting Knob (7), Spring (8), and Needle (9).
2. Loosen Housing (10).
3. Remove Housing (10) and Airvalve Spring.
4. Remove Valve (11).
5. Using Service Tool SPN-7, engage groove behind the Valve Seat.
6. Remove Valve Seat.
7. Push out the Front Airvalve Seal with a finger.
8. Turn the Gun upside down and let the Seal fall out.
9. Fit New Front Seal to Service Tool.
10. Fit new Seal to gunbody and press

firmly to ensure Seal is engaged.

11. Fit New Valve Seat to Service Tool. Groove must face outwards.
12. Fit Valve Seat to Gunbody.
13. Remove Rear Airvalve Seal from housing (10) with a hooked instrument.
14. Fit new Seal to Service Tool.
15. Fit Seal to Housing (10).
16. Replace Valve (11).
17. Replace Valve Spring and screw in Housing (10).
18. Tighten Housing.
19. Fit Needle (9).
20. Fit Spring (8) and Knob (7).
21. Adjust Needle Packing (4) with Spanner sufficient to seal but to allow free movement of needle. Lubricate with gun oil.

Spreader valve (5) – Caution: always ensure that the valve is in the fully open position by turning screw fully counter-clockwise before fitting to body.

Air cap / Nozzle Selection

Refer to coating material manufacturers recommendations or ITW Finishing UK Website:

www.itweuropeanfinishing.com

FIG 2

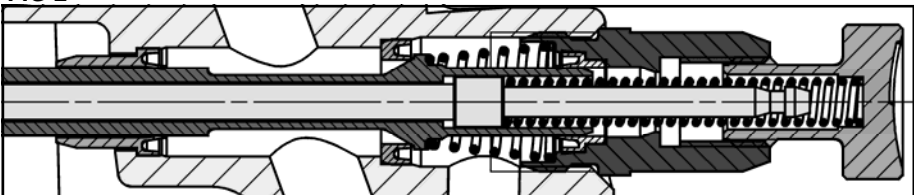

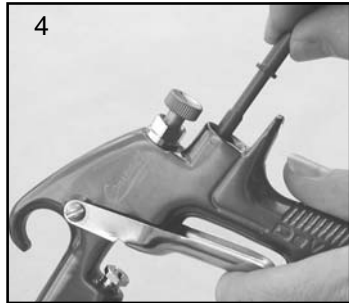
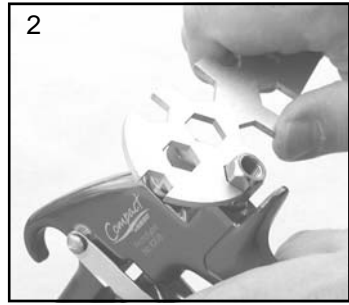
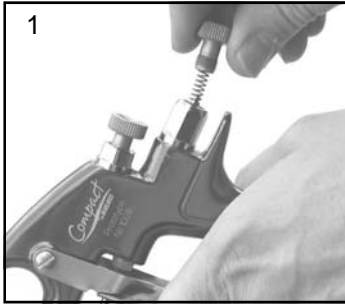

E

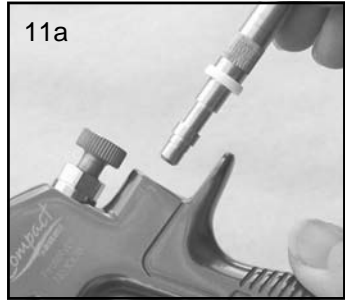
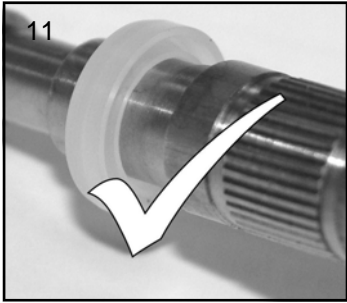

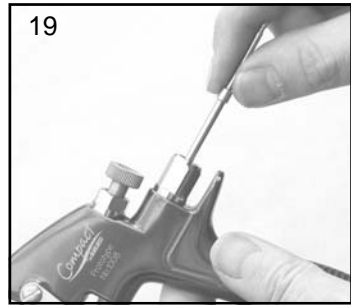

Accessories

Spanner – order SPN-5

Cleaning Brush – order 4900-5-1-K3

Regulator/Gauge Attachment - order HAV-501-B

Pressure gauge Attachment – order GA-515

Gun Mounted Regulator – order DVR-501

Spraygun Lubricant - order GL-1-K10



Roundspray Aircap - COM-500R

HVLP Mode - Air Inlet Pressure = 1.0 Bar (14.5 PSI)

Tanstech Mode – Air Inlet Pressure = 2 bar (29 PSI)

Approx Spot Size = Ø50mm

BINKS DVP 1:1 RATIO DIAPHRAGM PUMP PACKAGES



PRESSURE FEED TANKS & CUPS

- Sizes to suit all applications
- 10, 40 & 60 litre capacity tanks complete with nylon inner container for easy colour changes and cleaning
- Stainless steel and mild steel options
- Compatible with your standard gun and hose connections
- Remote pressure cups – aluminium and stainless steel options
2 litre capacity
- ATEX/CE approved.

ITW Industrial Finishing – Masters of Finishing Technology
www.itwifeuro.com

ITW Finishing Systems and Products

Ringwood Road,

Bournemouth,

BH11 9LH,

England.

Tel. No. (01202) 571111

Telefax No. (01202) 581940,

Website address <http://www.itweuropeanfinishing.com>

ITW Oberflächentechnik GmbH & Co. KG

Justus-von-Liebig-Straße 31

63128 Dietzenbach

Tel (060 74) 403-1

Telefax: (060 74) 403300

Website address <http://www.itw-finishing.de>

ITW Surfaces Et Finitions

163-171 avenue des Auréats B.P. 1453

26014 VALENCE CEDEX FRANCE

Tél. (33) 475-75-27-00

Télex 345 719F DVILBIS

Téléfax: (33) 475-75-27-99

ITW Finishing Systems and Products is a Division of ITW Ltd. Reg. Office:

Admiral House,

St Leonard's Road,

Windsor,

Berkshire,

SL4 3BL,

UK

Registered in England: No 559693 Vat No 619 5461 24